



#### Genel açıklama:

T/CC-ATX serisi aksiyal fanlar exproof motorları ile ATEX sınıfı Zone 1 / 2 Grup: IIA, IIB ve IIC olarak kullanılabilir.

Çapları 450mm'den başlayıp 1000mm'ye kadar 12 farklı model vardır. Çalışma aralığı temiz hava şartlarında -20°C ile +50°C aralığında öngörülmüştür.

#### Yapı:

Gövde malzemesi galvaniz sacdan; kanat malzemesi ise alüminyumdan oluşur.

#### Motor:

Motor tipi TEFC olup, motor verim sınıfı IE2'dir. Motor yalıtımı sınıfı F; koruma sınıfı IP55'dür.

#### Başka Opsiyonlar:

İstenilen debi ve basınca özel üretim; alüminyum ve plastik kanat seçeneği, çift devirli motor seçeneği

#### Aksesuarlar:

Trifaze Frekans Konvertörü (T/TPFC), Koruma Teli (T/CCr), Aksiyal Fan Montaj Ayağı (T/CCst), Düz Karşı Flanş (T/CCf), Konnektör (T/CCga), Titreşim Takozu (T/CCvf), Titreşim Yayı (T/CCvs) Kontrol Panosu (T/SC) Yuvarlak kanal tipi susturucu (T/CCsa)

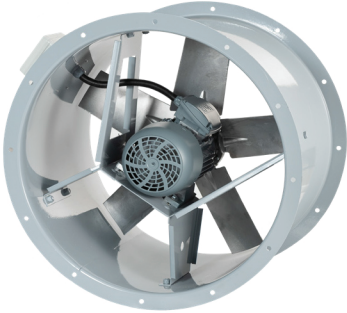

# T/CC-ATX

## T/CC-ATX Serisi: Kanal Tipi Aksiyal Fan Exproof Motor

Artikel	Model	Ø	U	RPM	U	P	Pm	In	IP/CI	Min	Q	Lw
		(mm)	T/M	(d/dk)	(V-Hz)	(n°)	(kW)	(A)		Max	(m³/h)	
TCCAT00	T/CC-ATX 450-5-25	450	T	1456	380V-50Hz	4	0,55	1,60	55/F	-20/50	4180	69
TCCAX01	T/CC-ATX 500-5-25	500	T	1453	380V-50Hz	4	0,55	1,60	55/F	-20/50	5845	72
TCCAX02	T/CC-ATX 560-5-25	560	T	1466	380V-50Hz	4	0,75	2,10	55/F	-20/50	8150	75
TCCAX03	T/CC-ATX 630-5-30	630	T	1465	380V-50Hz	4	1,10	2,80	55/F	-20/50	13480	80
TCCAX04	T/CC-ATX 710-5-30 T4	710	T	1472	380V-50Hz	4	1,50	3,70	55/F	-20/50	19210	83
TCCAX05	T/CC-ATX 800-5-30	800	T	1459	380V-50Hz	4	2,20	5,30	55/F	-20/50	25560	85
TCCAX06	T/CC-ATX 800-5-35	800	T	1463	380V-50Hz	4	3,00	6,40	55/F	-20/50	30940	89
TCCAX07	T/CC-ATX 900-5-35	900	T	1471	380V-50Hz	4	4,00	8,60	55/F	-20/50	39250	90
TCCAX08	T/CC-ATX 900-5-40	900	T	1472	380V-50Hz	4	5,50	11,80	55/F	-20/50	44635	93
TCCAX09	T/CC-ATX 1000-5-40	1000	T	1478	380V-50Hz	4	7,50	15,40	55/F	-20/50	54570	94
TCCAX10	T/CC-ATX 900-8-40	900	T	1454	380V-50Hz	4	11,00	22,40	55/F	-20/50	46200	94
TCCAX11	T/CC-ATX 1000-8-40	1000	T	1456	380V-50Hz	4	15,00	30,40	55/F	-20/50	62250	97

## ÖLÇÜLER

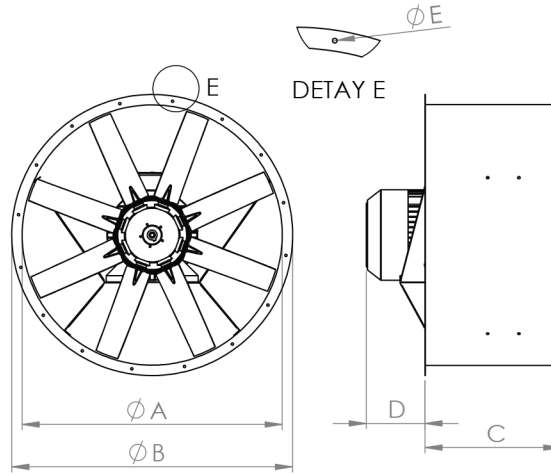

Article	Model	A (mm)	B (mm)	C (mm)	D (mm)	E (mm)	N Delik (ad)
TCCAT00	T/CC-ATX 450-5-25 T4 0,55 kW	450	530	320	50	11	8
TCCAX01	T/CC-ATX 500-5-25 T4 0,55 kW	500	580	320	70	11	8
TCCAX02	T/CC-ATX 560-5-25 T4 0,75 kW	560	640	320	60	11	12
TCCAX03	T/CC-ATX 630-5-30 T4 1,1 kW	630	710	420	45	11	12
TCCAX04	T/CC-ATX 710-5-30 T4 1,5 kW	710	790	420	25	11	12
TCCAX05	T/CC-ATX 800-5-30 T4 2,2 kW	800	880	420	50	11	16
TCCAX06	T/CC-ATX 800-5-35 T4 3 kW	800	880	420	50	11	16
TCCAX07	T/CC-ATX 900-5-35 T4 4 kW	900	980	520	0	11	16
TCCAX08	T/CC-ATX 900-5-40 T4 5,5 kW	900	980	520	35	11	16
TCCAX09	T/CC-ATX 1000-5-40 T4 7,5 kW	1000	1080	520	150	11	16
TCCAX10	T/CC-ATX 900-8-40 T4 11 kW	900	980	520	75	11	16
TCCAX11	T/CC-ATX 1000-8-40 T4 15 kW	1000	1080	520	180	11	16

T/CC-ATX 450-5-25 T4 0,55 kW

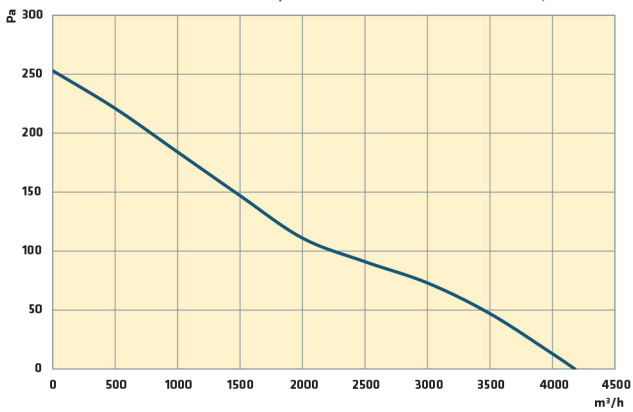

T/CC-ATX 500-5-25 T4 0,55 kW

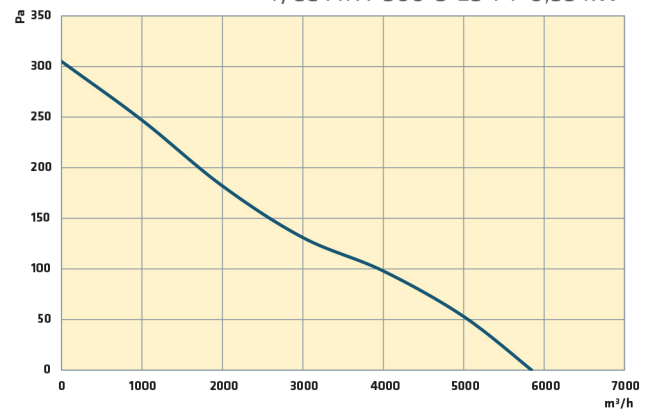

T/CC-ATX 560-5-25 T4 0,75 kW

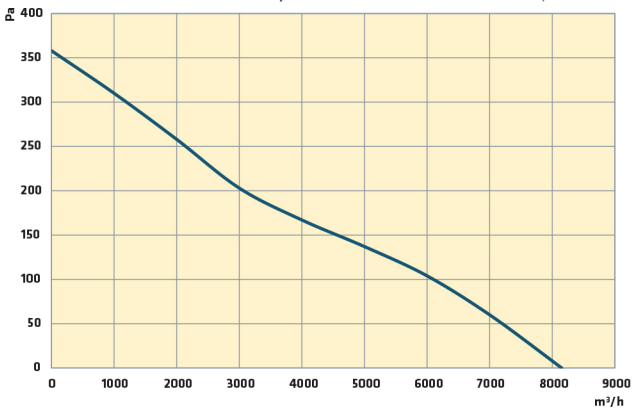

T/CC-ATX 630-5-30 T4 1,10 kW

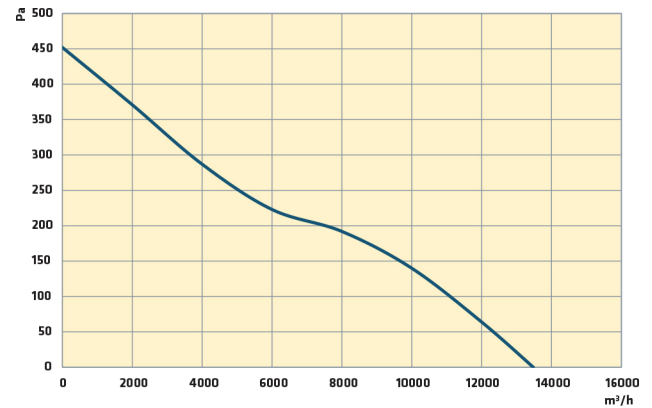

T/CC-ATX 710-5-30 T4 1,50 kW

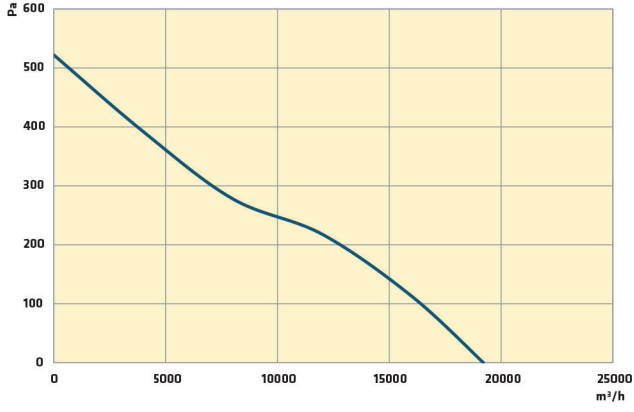

T/CC-ATX 800-5-30 T4 2,20 kW

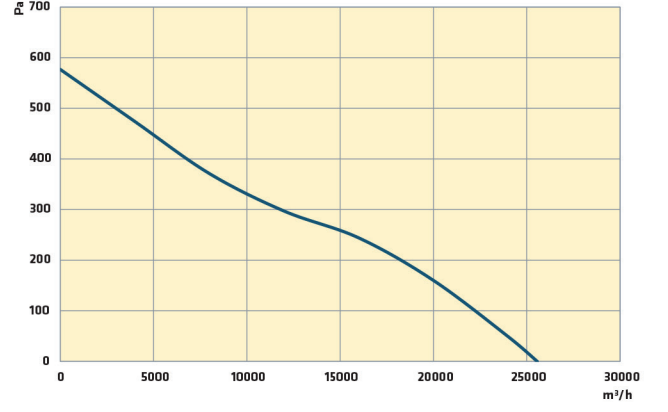

T/CC-ATX 800-5-35 T4 3,00 kW

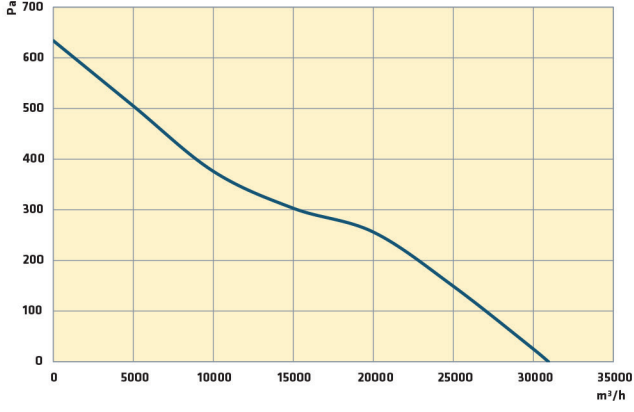

T/CC-ATX 900-5-35 T4 4,00 kW

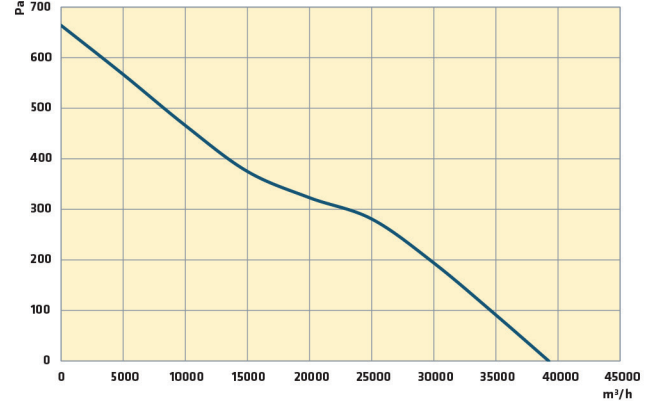

T/CC-ATX 1000-5-40 T4 7,50 kW

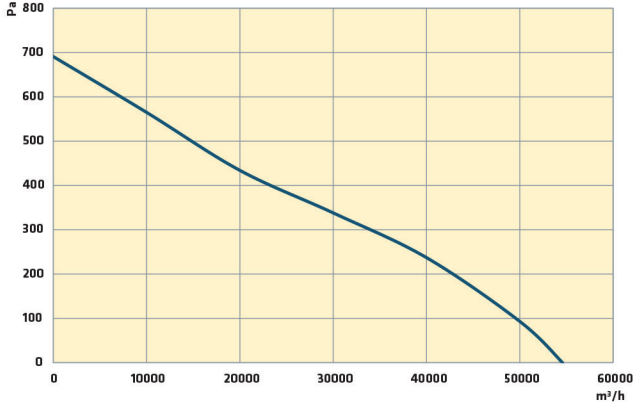

T/CC-ATX 900-8-40 T4 11,00 kW

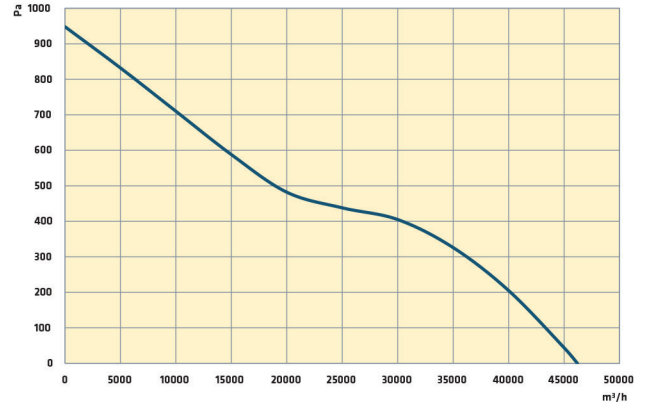

T/CC-ATX 1000-8-40 T4 15,00 kW

